

CO-CURRENT DRYING IN HIGH-REVOLUTION ROTARY DRYER

Ing. Dusan Nascak, PhD

Ing. Jan Mikula, PhD

Ing. Jan Kerekanic

Development And Realization Workplace Of Raw Materials Extracting And Treatment, Faculty Of Mining, Ecology, Process Control And Geotechnology, Technical university of Kosice, Slovak Republic

Abstract

The high-revolution rotary dryer was developed for the biomass thermal treatment. The apparatus operates on the mechanical fluidization principles, which are achieved by the effect of centrifugal and gravitational forces. Centrifugal forces are growing by increasing the revolutions. With their influence, the fluidized material is uprising and by influence of gravitation forces is passing down to the lower part of the equipment. At critical revolutions, a balancing of centrifugal and gravitational forces is achieved. At this situation the fluidized material is filling the whole apparatus section. Thus, individual, longitudinal and transversal particular motion is achieved. At critical revolutions, the optimal conditions for heat transfer are created. Fluidized heat transfer surface is approaching to the whole surface of individual particles. Also because of radial and axial particular movement the heat transfer coefficient is growing and one order is higher as with classical dryers. High–revolution rotary dryer was used for biomass drying. Effective drying of this material enables its technological utilization. In this contribution characteristics of high-revolution rotary dryer are presented, the mathematical model was developed, simulation of drying process and proving on experimental device were implemented. The results prove adequacy of the proposed technology and their effective utilization.

Keywords: Biomass, drying, high-revolution rotary dryer

Introduction

Biomass currently belongs to the most important renewable energy sources. One of the principal reasons for using a biomass as energy sources are its low price and environmental reasons. The conversion of biomass into energy is generally more expensive than energy produced from fossil fuels.

Low efficiency of biomass energy is currently one of the major obstacles of its wider use due to logistical, technological and technical reasons. The creation of efficient systems enables to reduce investment and operational costs of biomass extraction and treatment. The use of biomass is primarily carried out at the regional, municipal and individual level, which is possible appropriately combined according to specific conditions. From an objective point of view the most important are the technologies used in different stages of biomass recovery and their technical solution. Drying processes are one of the principal methods of the biomass thermal treatment and processing. Drying of biomass generally precedes its further processing or utilization.

1. Drying process characteristic:

A term of drying characterizes the reduction process of moisture content of any material. The moisture is removed by passing from moistening liquid state to vapour and by its disposal from the material surface through drying media. Total moisture is the sum of free and bound water. Free (surface) moisture can be removed from the material by drying. The first phase of drying is ended by achieving a critical point of drying and by reduction of the surface moisture to 0. The bound (capillary) moisture we can remove at higher temperatures. When the surface moisture of the material is equal to zero, a second drying phase is occurred. Thus, evaporation is moved to inside of the particles of the dried materials and an evaporate moisture passes through the capillaries to the particles surface.

Vapor gets into a drying medium through a layer of the dried material by diffusion where is entrained by flowing medium. Drying methods are indirect and direct. At indirect drying, there is no direct contact of drying medium with biomass. Heat is transferred to the dried material through thermal surfaces. At direct drying, the dried material is in direct contact with a drying medium. The most principal types of the driers are following: rotary drum dryer, belt dryer and fluidized dryer. There has been developed a new type of dryer at Development and Realization Workplace of the Faculty BERG, the Technical University of Kosice that combines the advantages of the rotary and fluidized dryers. This developed equipment operates on the principle of mechanically fluidized layer.

1.2 Drying in mechanically fluidized layer

The hydrodynamic processes are designed to ensure heat and substances transfer between material particles and gaseous medium. Mechanical fluidization takes place through the centrifugal and gravitational forces. Formation of fluidized layer depends on material parameters, equipment and conditions of fluidized process. Material distribution through

the dryer cross section depends on the dryer revolutions. In Fig. 1 is shown a distribution of the material at change of the number of revolutions.

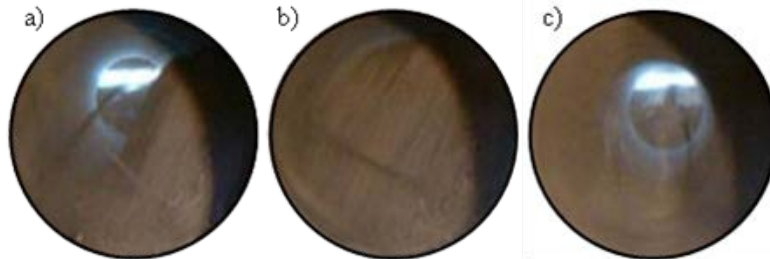

Fig. 1 – Distribution of the material particles at mechanical fluidization through the dryer cross section a) without revolutions b) low revolutions c) optimal revolutions

The influence of the gaseous medium axial velocity leads to the particles entrainment. The total amount of the entrained particles depends on the gaseous medium velocity. The influence of the gaseous medium axial velocity on the amount of the entrained particles is shown in Fig. 2. The following areas are characteristic for dependence of the entrained particles on the gaseous medium axial velocity: low entrainment area and high entrainment area. The velocity on the limit of these areas can be considered as a maximum flow velocity of the gaseous medium in the dryer while its increase would lead to a large increase in the amount of flue dust. The apparatus performance determines required amount of the medium per surface unit of its cross-section.

The amount of the gaseous medium determines a surface cross section of the apparatus. The pressure losses in the apparatus are low and are used to overcome the resistance by friction between particles.

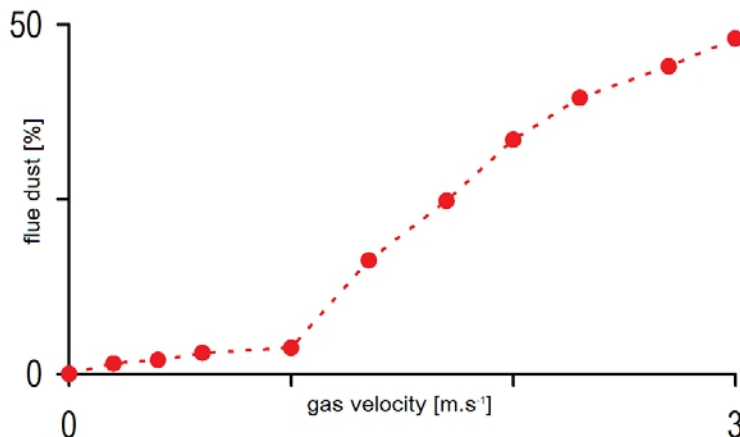

Fig. 2 – Dependence of the amount of entrained fine particles on the gaseous medium velocity in high-revolution rotary dryer

Active surface of the treated material is near the surface of the fluidized particles allocated at the dryer cross-section (Fig. 3).

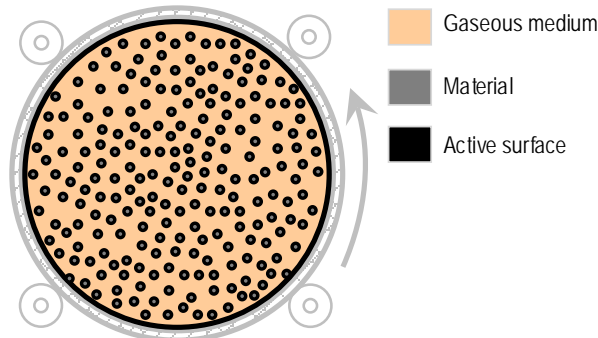

Fig. 3 –Material distribution through the dryer cross section

2. High-revolution rotary dryer:

The drying principle in the mechanically fluidized layer was used during development of the high-revolution rotary dryer (HRD). When designing equipment, the technological data were placed to meet the purpose of the equipment and also the additional utility qualities. The proposal research was conducted on the cold model of high-revolution rotary dryer (Fig. 4). The aim of the research was to determine influence of the layer thickness of the material on the size of the critical revolutions causing fluidization and influence of the fluidization on pressure loss in the equipment.



Fig. 4 –Experimental model of high-revolution rotary dryer

With increasing the revolutions, due to centrifugal forces the discharging of the material through wall of the equipment is occurred. Due to gravitational forces, the material is come down to the dryer bottom. At the critical revolutions, the material fills the entire cross section of the dryer. The main advantage of this solution is the intense heat transfer, which is achieved when individual grains of the material are individually involved in the heat transfer between the surface material and flue dust. Thus, the optimal conditions for heat transfer are created and the heat-exchange area is significantly increased. Due to terminal and rotary velocity

of the material, the coefficient of heat transfer is increased. Conceptually, the equipment can be classified as a high-intensity thermal apparatus. The operation scheme of high-revolution rotary dryer is shown in Fig. 5.

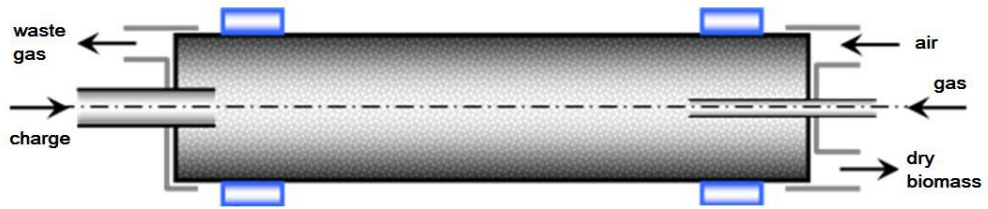

Fig. 5 – Scheme of high-revolution rotary dryer

Heat and constructional-technical parameters were verified on the pilot model of high-revolution rotary dryer. In Fig. 6 is shown a view of the pilot model of high-revolution rotary dryer.

An implementation of the pilot dryer was carried out according to the developed project. The project was developed based on the research. Based on the simulations results of the different variant of the dryer setting, the construction and auxiliary components of the equipment were designed and manufactured (Fig. 7).



Fig. 6 – Pilot model of high-revolution rotary dryer



Fig. 7 –Pilot high-revolution rotary dryer

3. Drying process simulation verification in HRD:

The mathematical simulation model was established for the virtual verification of the drying process course and characteristics. It includes following:

- data base - information about equipment and process,
- simulation model - mathematical equations and functions solving,
- visualization part - presentation of the results, graphs, courses (trajectories) of the process.

A calibration of the mathematical model was created by physical modelling. Thereby, data for the correct setting of all input parameters were obtained. An advantage of this solution is the ability to perform "digital" experiments, where it is not necessary to interfere to the existing equipment.

Development of the simulation model was arose from the developed partial models affected the choice of the calculating method. The method of elementary balances was chosen for the sequential model using the replacement partial models. There is considered the technological process where the treated material passes through the apparatus and a gaseous medium passes through the material. The processes run by their mutual interaction. The mathematical model is designed as one-dimensional. Through width of the equipment, the material is considered as a homogeneous and its motion is imitated by piston flow.

3.1 Models of the processes evaporation and condensation

The models are based on the functional dependence of the saturated vapour partial pressure on the temperature. The amount of condensed vapour is determined from the difference between partial vapour pressure and actual partial vapour pressure according to the equation:

$$m_{H_2O} = V_{gas} \rho \left(\frac{P_p}{P} - H_2O \right)$$

The ratio of the amount of water vapor (W) and dry air (DA) in molar units may be expressed by the formula:

$$\frac{\frac{W}{18}}{\frac{DA}{29}} = \frac{29}{18} \frac{W}{DA} = 1,61 \frac{W}{DA}$$

This ratio is equal to the ratio of partial pressures:

$$\frac{W}{DA} = \frac{1}{1,61} \frac{P}{p - p_p} = 0,622 \frac{P}{p - p_p}$$

The amount of evaporated water is expressed by the formula:

$$m_{H_2O} = 0,622 \frac{\alpha \cdot S}{c_{p_gas}} \left(\frac{P_p}{p - p_p} - \frac{H_2O}{1 - H_2O} \right)$$

where m_{H_2O} - the amount of water or vapor, $kg.s^{-1}$; V_{gas} – the amount of gas, $m^3.s^{-1}$; ρ - vapor density in dependence of temperature, $kg.m^{-3}$; p_p - partial saturated vapor pressure, Pa; p - total pressure of gas mixture, Pa; H_2O - representation of vapor in the gas mixture; α - heat transfer coefficient by flow, $W.m^{-2}.K^{-1}$; c_{p_gas} - specific heat capacity of the medium, $J.kg^{-1}.K^{-1}$; S – exchange area, m^2 ; 0,622 - the amount of water and water vapor density.

3.2 Co-current biomass drying

Several variants of the device setting were verified by simulations. A mathematical model was calibrated based on a comparison of simulations with physical experiments results (Tab. 1, Fig. 8).

Tab. 1 – Calibration of mathematical model (co-current flow)

Parameter	Experiment	Simulation	
Charge	100	100	kg/h
Input moisture	30	30	%
Furnace infilling	-	25	%
Work length	-	2,5	m
Product	85	86,2	kg/h
Input of natural gas	4,5	4,5	m^3/h
Flue gas temperature	51,4	80,7	$^{\circ}C$
Output material temperature	41,1	71	$^{\circ}C$
Losses through walls+ accumulation	-	46	%
Flue gas velocity	-	0,27	m/s

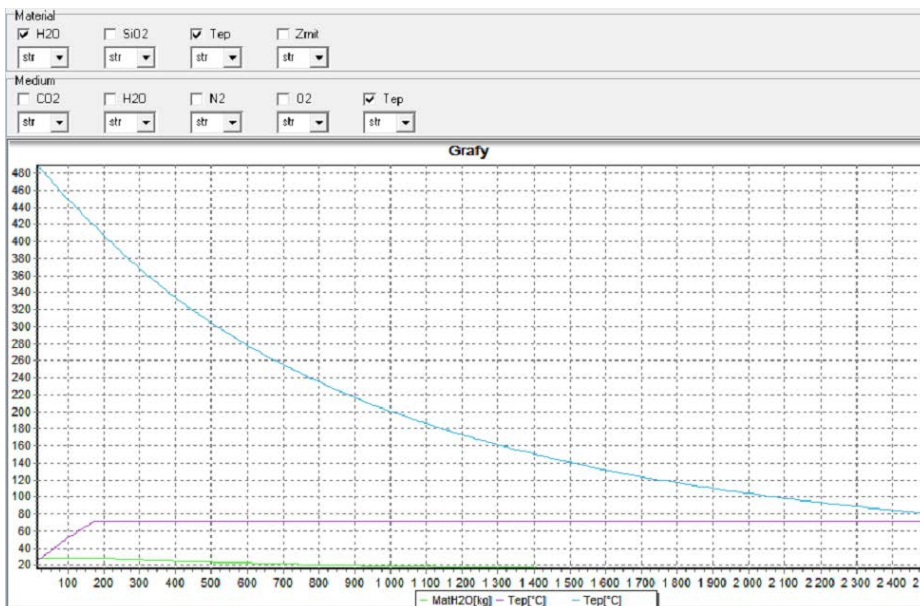

Fig. 8 – Simulation results for the mathematical model calibration

Input parameters of the first alternative are shown in Tab. 2. Filling of the device cross-section by the material to 20, 25 and 30 % has been considered. Output parameters (Table 3) and values courses (Fig. 9) are presented with 25 % filling of the cross section of the dryer by the material.

Tab. 2 – Input parameters for simulation

Input biomass	2400	kg/h
Density	400	kg/m ³
Input moisture	35	%
Dryer work length	6	m
Dryer inner diameter	2	m
Fresh flue gas volume	2900	m ³ /h
Flue gas temperature	480	°C
Maximal velocity of flue gas through cross section	0,31	m/s
Fresh flue gas moisture	4,8	%
Losses through walls	16	%

Tab. 3 – Output parameters from simulation (filling 25 %)

Filling 25 %						
Work length [m]	Mass of water in biomass [kg/h]	Evaporation of water [kg/h]	Residual moisture [%]	Tgas [°C]	Tmat [°C]	Product [kg/h]
0,1	840	0	35	467	30	2400
1	651	189	29	274	71	2211
2	507	333	25	178	71	2067
3	432	408	22	130	71	1992
4	392	448	20	103	71	1952
5	371	469	19	87	71	1931
6	362	478	19	78	71	1922

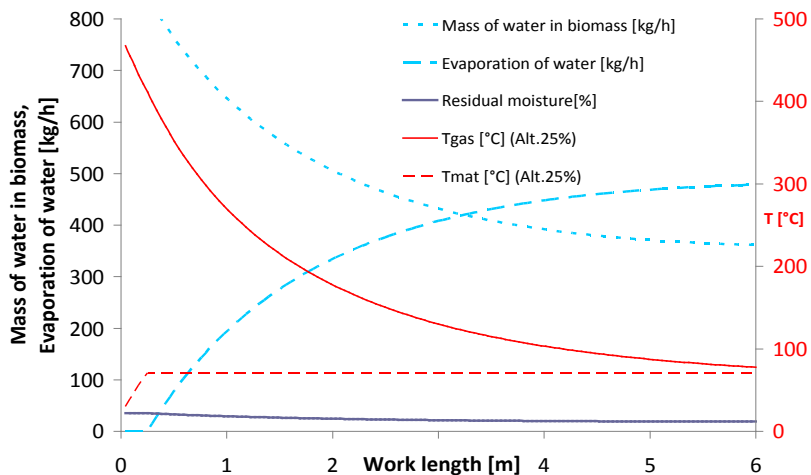

Fig. 9 – The resulting values of 25% filling

At second alternative, such parameters as the amount of input charge (depending on drop of material moisture – 20 %), inner diameter of the equipment, the ratio of percentage filling of the furnace cross section by the materials etc. (Tab. 4) have been changed.

Tab. 4 – Changed input parameters for simulation

Input biomass	1800	kg/h
Density	400	kg/m ³
Input moisture	35	%
Dryer work length	6	m
Dryer inner diameter	1,9	m
Fresh flue gas volume	2600	m ³ /h
Flue gas temperature	480	°C
Maximal velocity of flue gas through cross section	0,31	m/s
Fresh flue gas moisture	4,8	%
Losses through walls	16	%

Output parameters are shown in Tab. 5 and values courses in Fig. 10.

Tab. 5 – Output parameters from changed simulation

Work length [m]	Mass of water in biomass [kg/h]	Evaporation of water [kg/h]	Residual moisture [%]	T _{gas} [°C]	T _{mat} [°C]	Product [kg/h]
0,1	630	0	35	469	30	1800
1	482	148	29	294	71	1652
2	364	266	24	201	71	1534
3	297	333	20	149	71	1467
4	257	373	18	118	71	1427
5	233	397	17	98	71	1403
6	221	409	15	85	71	1391

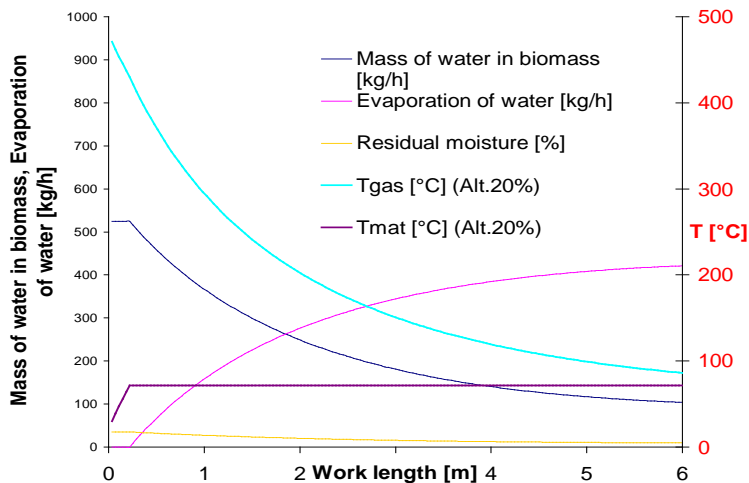

Fig. 10 – The resulting values for 20% filling

3.3 Comparison of biomass co-current dryers

High-revolution rotary dryer for biomass drying was compared with another type of the used co-current biomass dryers. The results of comparison are shown in Tab. 6. In Fig. 11 is schematically presented the Drum M-829 dryer.

Tab. 6 – Comparison of the high-revolution rotary dryer parameters and other co-current biomass dryers

Parameters	High-revolution rotary dryer	Drum dryer M-829 (www.agromech.info.pl)	
Input material moisture	50	45–50	%
Product (moisture under 0,5 %)	1 000	1 000	kg/h
Natural gas consumption	86	110–120	m ³ /h
Fresh flue gas volume	3 800	-	m ³ /h
Fresh flue gas temperature	600	600–650	°C
Dryer work length	6	9	m
Dryer inner diameter	1,8	1,8	m
Product temperature	100	-	°C
Flue gas temperature	121	-	°C
O ₂ in flue gas	12,2	-	%

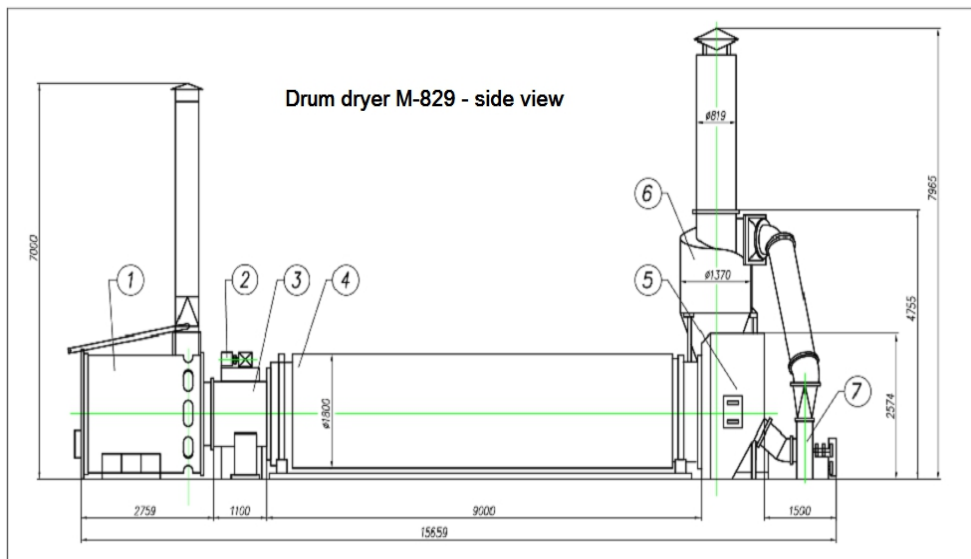

Fig. 11 - Scheme of Drum dryer M-829

4. Use of waste heat for biomass drying:

The equipment is also suitable for the use of excess heat from the technological objects. Use of waste heat from the cogeneration unit Tedom Cento T150 has been considered. The drying process of beech raw chips with a moisture content of 50% in co-current is shown in Fig. 12.

An increase in heating value of the chips from 16 MJ/kg to 18 MJ/kg was achieved by drying.

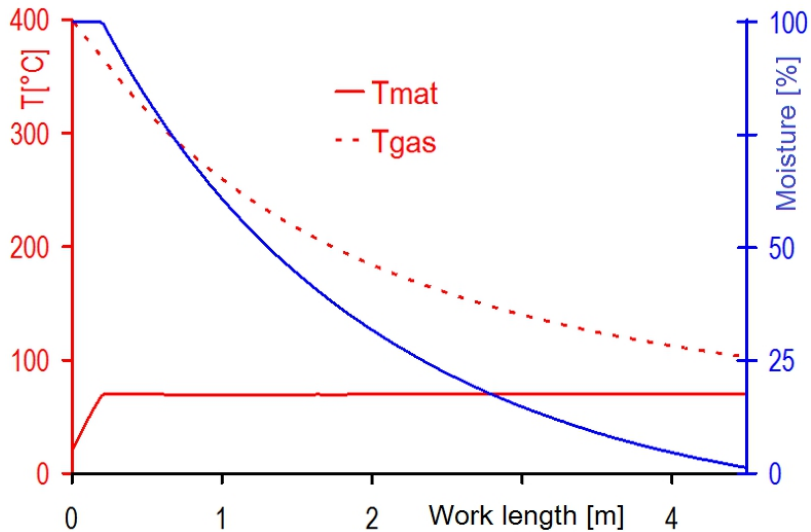

Fig. 12 – Drying process in high-revolution furnace

Conclusion

A greater energy recovery and also greater use of waste heat from energy and technological equipment can be achieved by biomass drying. Presented concept of grain and dust materials drying in high-revolution dryer compared with conventional technologies allows process to be much more efficient. An intensive heat exchange and thus a high efficiency of the drying process are ensured by high revolutions in high-revolution dryer. The furnace in comparison with traditional rotary dryers has smaller sizes and a greater efficiency of drying. It seems to be a suitable replacement for existing equipment used for waste heat recovery. For the analysis and design of the drying process in high-revolution dryer, a mathematical model was created. A model adequacy of the simulated process was verified. The functionality of the model was verified by simulations. A calibration was conducted on the experimental high-revolution dryer. After model calibration, some alternatives were simulated. Comparing the simulation results, it was concluded that the digital model is adequate to the real process as the results were almost identical. The model permits to optimize the process in the design phase and during the operational phase.

Acknowledgment:

This contribution/publication is the result of the project implementation new technologies for the effective energetic environmental and economic biomass assessing supported by the Research & Development Operational Programme funded by the ERDF. (ITMS: 26220220063)

References:

- Kostial, I., Spisak, J., Mikula, J., Glocek, J., Nemcovsky, P., Terpak, J. (2008). Advanced process manipulation of magnesia sintering. In: 17th IFAC World Congress, Seoul, IFAC, p. 718-723. - ISBN 9781123478902.
- Kostial, I., Terpak, J., Mikula, J. (2005). Behavioural modelling of complex thermal systems. In: International Carpathian Control Conference 2005. Miskolc-Lillafured, Hungary: University of Miskolc, pp. 297-302.
- Kostial, I., Nascak, D., Mikula, J. (2013). Technogenic waste drying in high-revolution rotary furnace. In: Keramicky zpravodaj. Vol. 29, no. 1, p. 10-16. - ISSN 1210-2520.
- Mikula, J., Nascak, D., Spisak, J., Kostial, I. (2009). Mathematical modelling of lumpy and granular material thermal treatment. In: Acta Metallurgica Slovaca. Roc. 15, mimoriadne c. 1, p. 197-204. - ISSN 1335-1532.
- Kostial, I., Mikula, J., Nascak, D., Glocek, J. (2012). New technologies for granular materials thermal treatment. In: SGEM 2012, 12th International Multidisciplinary Scientific GeoConference, conference proceedings, Volume 2, 17-23 June, 2012, Albena, Bulgaria. – Sofia, STEF92 Technology Ltd., p. 415-423. - ISSN 1314-2704.